

03

0317

Rundsteckverbinder mit Schraubverschluss M16 nach IEC 61076-2-106, IP40/IP68



Einbaustecker nach IEC 61076-2-106, IP68, mit
Schraubverschluss, für Leiterplatten, für
Rückseitenmontage

03 0317

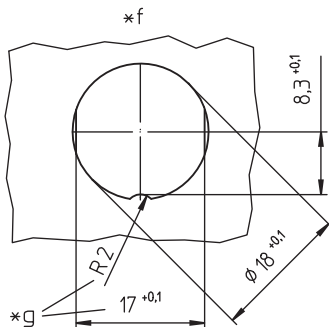
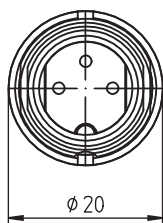
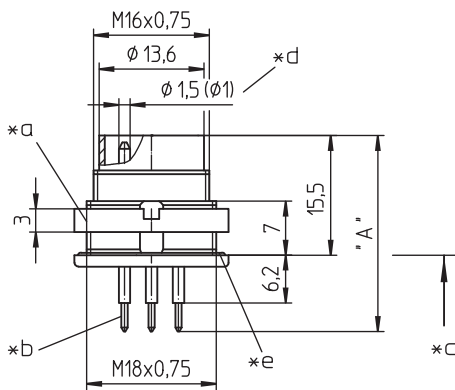
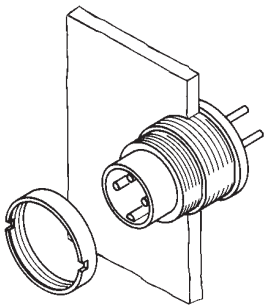

Umgebungsbedingungen

Temperaturbereich -40 °C/+85 °C

Werkstoffe

Kontaktträger	PA GF, V-0 nach UL94
Kontaktstift	CuZn, versilbert und flashvergoldet, im Lötbereich verzinkt (3- bis 8-polig) CuZn, unternickelt und vergoldet, im Lötbereich verzinkt (12- bis 14-polig)
Gehäuse	Zn-Druckguss, unterkupfert und vernickelt
Ringmutter	CuZn, vernickelt
Dichtung	NBR

Mechanische Daten

Anzugsdrehmoment Steckverbinder	1-3 Nm
Anzugsdrehmoment Mutter	1-3 Nm
Schutzart	IP68 ¹

¹ nach IEC DIN EN 60529, nur in verschraubtem Zustand mit einem dazugehörigen Gegenstück; IPX8-Anforderungen in Absprache zwischen Anwender und Hersteller

Elektrische Daten (bei T_v 20 °C)

Bemessungsstrom	5 A (T _v 40 °C, 3- bis 8-polig) 3 A (T _v 40 °C, 12- bis 14-polig)
Bemessungsspannung	bei Verschmutzungsgrad 1: 300 V (Polbilder 03, 04, 05-1, 06, 07) 100 V (Polbilder 05, 07-1, 08, 08-1) 160 V (Polbilder 12, 14) bei Verschmutzungsgrad 2: 250 V (Polbilder 03, 04) 32 V (Polbilder 05, 07-1, 08, 08-1) 160 V (Polbilder 05-1, 06, 07, 12, 14)
Bemessungsstoßspannung	1500 V (Polbilder 03, 04, 05-1, 06, 07, 12, 14) 500 V (Polbilder 05, 07-1, 08, 08-1)
Isolierstoffgruppe	II (IEC)/I (UL) (400 ≤ CTI < 600)
Überspannungskategorie	I
Isolationswiderstand	> 100 MΩ

Zugehörige Produkte

Gegenstücke			
☞ 0321	☞ 0322	☞ 0322-1	
☞ 032200	☞ 0360	☞ 036000	
Zubehör			
☞ 0383	☞ 038399	☞ 0384	

03

0317

Polbilder, von der Lötseite gesehen

 0385

 038899

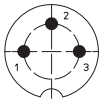

03-a
0317 03

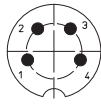

04-a
0317 04

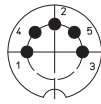

05-b
0317 05

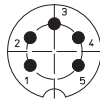

05-a
0317 05-1

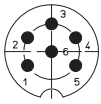

06-a
0317 06

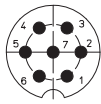

07-a
0317 07

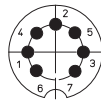

07-b
0317 07-1

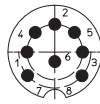

0317 08

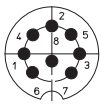

08-a
0317 08-1

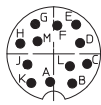

12-a
0317 12

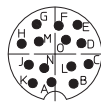

14-a
0317 14

03

0317

Leiterplattenlayout, von der Lötseite gesehen

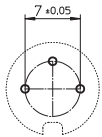

03-a
0317 03

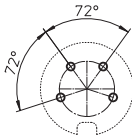

04-a
0317 04

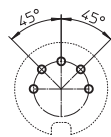

05-b
0317 05

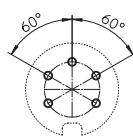

05-a
0317 05-1

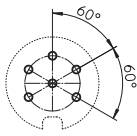

06-a
0317 06

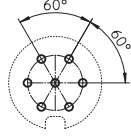

07-a
0317 07

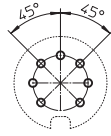

07-b
0317 07-1

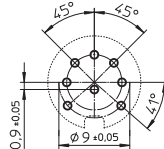

0317 08

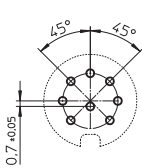

08-a
0317 08-1

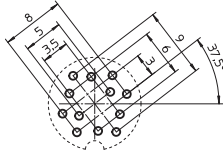

12-a
0317 12

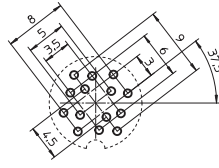

14-a
0317 14

- *a Mutter lose beigestellt
- *b für Leiterplattenbohrung
Ø 1,0 mm (0317 03–0317 08-1)
Ø 0,7 mm (0317 12–0317 14)
- *c Montagerichtung
- *d Kontaktstift
Ø 1,5 mm (0317 03–0317 08-1)
Ø 1,0 mm (0317 12–0317 14)
- *e O-Ring-Dichtung
- *f Einbauöffnung
- *g Verdrehschutz, Ausführung wahlweise

03

0317

Bestellbezeichnung	Polzahl	VE (Stück)	MDQ (Stück)	Abmessungen A (mm)
0317 03	3	50	100	25,4
0317 04	4	50	100	25,4
0317 05	5	50	100	25,4
0317 05-1	5	50	100	25,4
0317 06	6	50	100	25,4
0317 07	7	50	100	25,4
0317 07-1	7	50	100	25,4
0317 08	8	50	100	25,4
0317 08-1	8	50	100	25,4
0317 12	12	50	100	24,8
0317 14	14	50	100	24,8

Verpackung:
im Karton