

15

XSTO 1

RCA-Steckverbinder



RCA-Stecker nach JEITA RC-5231, gerade Ausführung, mit Knickschutz und Lötanschlüssen

15

XSTO 1

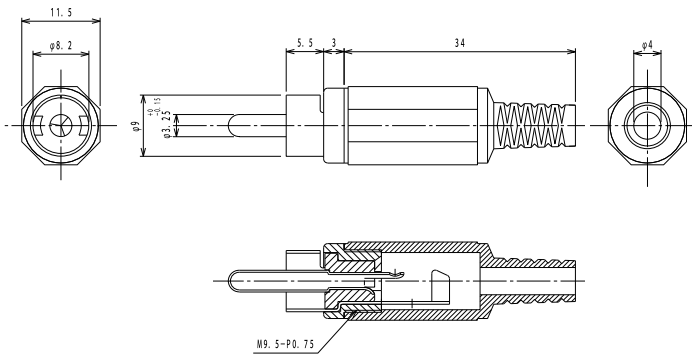

Umgebungsbedingungen

Temperaturbereich -20 °C/+70 °C

Werkstoffe

Kontaktträger	ABS
Innerer Kontakt	CuZn, vernickelt
Äußerer Kontakt	Stahl, vernickelt
Gehäuse	PE







Anschließbare Leiter Lötanschluss

Kabeldurchmesser 4 mm

Elektrische Daten (bei T_u 20 °C)

Bemessungsstrom	2 A
Bemessungsspannung	34 V AC/DC
Bemessungsstoßspannung	250 V/60 s
Isolationswiderstand	≥ 100 MΩ

Zugehörige Produkte

Gegenstücke		
 1553 02	 1571 01	 4514
 BTO 1	 BTO 1 V	 XKTO 1

15

XSTO 1

Bestellbezeichnung	Polzahl	VE (Stück)	MDQ (Stück)
XSTO 1 SCHWARZ (black)	2	100	1000

Verpackung:

lose im Karton oder Kunststoffbeutel