

01

0137

## DIN circular connectors



DIN plug with locking catch, straight version, shielded,  
with metal housing, bend protection and solder terminals

01

0137

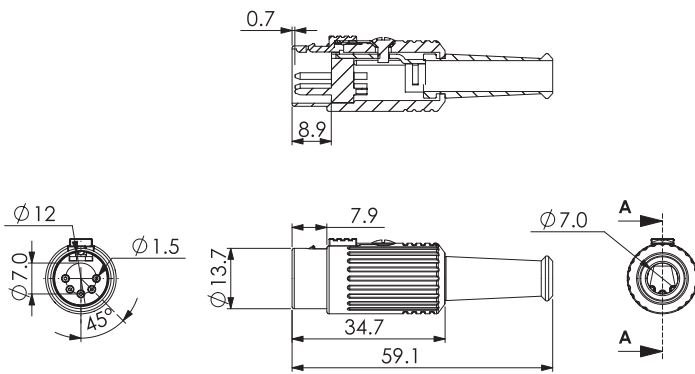

#### Environmental conditions

Temperature range -25 °C/+80 °C

#### Materials

Insulating body	PA, V-0 according to UL94
Contact pin	CuZn, silver-plated
Strain relief	steel, nickel-plated
Housing	Zn alloy, nickel-plated
Locking	Zn alloy, nickel-plated
Leaf spring	steel
Bend protection sleeve	PVC
Screw	steel, nickel-plated

#### Pin configurations, solder side view

DIN 41524

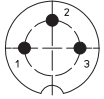

0137 03

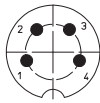

0137 04

DIN 41524

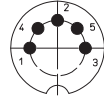

0137 05

DIN 45322

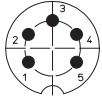

0137 05-1

DIN 45322

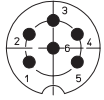

0137 06

DIN 45329

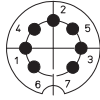

0137 07-1

DIN 45326

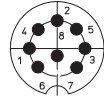

0137 08-1

#### Connectable conductors for solder area

Section	≤ AWG 19 (0.65 mm <sup>2</sup> )
Cable diameter	7,0 mm

#### Electrical data (at T<sub>amb</sub> 20 °C)

Rated current	4 A
Rated voltage	100 V AC
Rated impulse voltage	250 V AC RMS/60 s
Insulation resistance	≥ 100 MΩ

#### Associated products

Counterparts

☞ 0103

☞ 0105

☞ 010599

01

0137

Designation	Pole Number	PU (Pieces)	MDQ (Pieces)
0137 03	3	50	150
0137 04	4	50	150
0137 05	5	50	150
0137 05-1	5	50	150
0137 06	6	50	150
0137 07-1	7	50	150
0137 08-1	8	50	150

**Packaging:**

in individual plastic bags, in a cardboard box