

03 0305

Circular connectors with threaded joint M16 acc. to IEC 61076-2-106, IP40/IP67/IP68



Chassis socket acc. to IEC 61076-2-106, IP68, with threaded joint and solder terminals, for back side mounting

03 0305

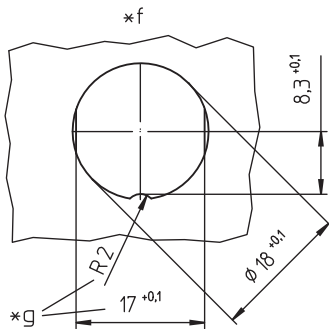
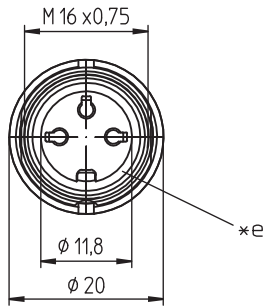
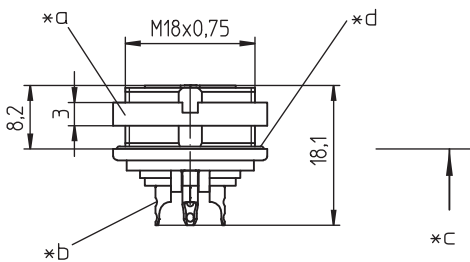
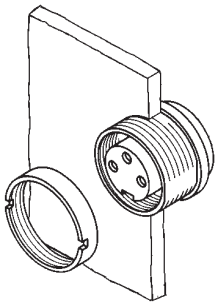

### Environmental conditions

Temperature range -40 °C/+85 °C

### Materials

Insulating body PA GF, V-0 according to UL94  
 Contact bush CuZn, silver-plated and flash gold-plated (3-8 poles)  
 CuZn, pre-nickel and gold-plated (12-14 poles)  
 Housing Zn diecast, pre-copper and nickel-plated  
 Ring screw CuZn, nickel-plated  
 Seal CR (flat), NBR (O-ring)

### Mechanical data

Insertion force/contact  $\leq 5.0 \text{ N}^1$   
 Withdrawal force/contact  $\geq 1.2 \text{ N}$  (3-8 poles)  
 $\geq 0.9 \text{ N}$  (12-14 poles)<sup>1</sup>  
 Tightening torque connector 1-3 Nm  
 Tightening torque nut 1-3 Nm  
 Protection class IP68<sup>2</sup>

<sup>1</sup> measured with a polished steel pin, nominal thickness 1.5 mm (1.0 mm with 12-14 poles)

<sup>2</sup> according to IEC DIN EN 60529, only in locked condition with an appropriate counterpart; IPX8 requirements under agreement between manufacturer and user

### Connectable conductors for solder area

Section  $\leq 0.75 \text{ mm}^2$  (AWG 20)  
 (3-8 poles)  
 $\leq 0.25 \text{ mm}^2$  (AWG 24)  
 (12-14 poles)

### Electrical data (at $T_{\text{amb}} 20 \text{ }^\circ\text{C}$ )

Contact resistance  $\leq 5 \text{ m}\Omega$   
 Rated current 5 A ( $T_{\text{amb}} 40 \text{ }^\circ\text{C}$ , 3-8 poles)  
 3 A ( $T_{\text{amb}} 40 \text{ }^\circ\text{C}$ , 12-14 poles)  
 Rated voltage with pollution degree 1:  
 300 V (versions 03, 04, 05-1, 06, 07)  
 100 V (versions 05, 07-1, 08, 08-1)  
 160 V (versions 12, 14)  
 with pollution degree 2:  
 250 V (versions 03, 04)  
 32 V (versions 05, 07-1, 08, 08-1)  
 160 V (versions 05-1, 06, 07, 12, 14)  
 Rated impulse voltage 1500 V (versions 03, 04, 05-1, 06, 07, 12, 14)  
 500 V (versions 05, 07-1, 08, 08-1)  
 Material group II (IEC)/1 (UL) (400  $\leq$  CTI < 600)  
 Overvoltage category I  
 Insulation resistance > 100 M $\Omega$

03

0305

Pin configurations, solder side view



**03-a**  
0305 03

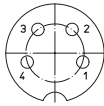

**04-a**  
0305 04

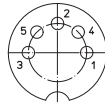

**05-b**  
0305 05

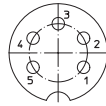

**05-a**  
0305 05-1

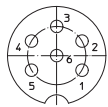

**06-a**  
0305 06

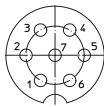

**07-a**  
0305 07

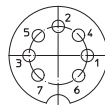

**07-b**  
0305 07-1

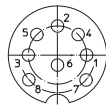

**0305 08**

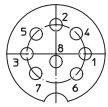

**08-a**  
0305 08-1

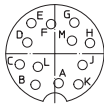



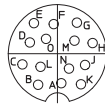



**12-a**  
0305 12









**14-a**  
0305 14

Associated products

Counterparts

 0331	 0332	 0332-1
 033200	 0365	 036500

Accessories

 0322 C 16	 0381	 038199
 0384	 0385	 038799

- \*a nut enclosed separately
- \*b cup-shaped solder terminal
- \*c mounting direction
- \*d O-ring gasket
- \*e flat gasket
- \*f port in mounting plate
- \*g anti-rotation, alternative execution

03 0305

Designation	Pole Number	PU (Pieces)	MDQ (Pieces)
0305 03	3	50	100
0305 04	4	50	100
0305 05	5	50	100
0305 05-1	5	50	100
0305 06	6	50	100
0305 07	7	50	100
0305 07-1	7	50	100
0305 08	8	50	100
0305 08-1	8	50	100
0305 12	12	50	100
0305 14	14	50	100

**Packaging:**  
in a cardboard box