

03 0306

Circular connectors with threaded joint M16 acc. to IEC 61076-2-106, IP40/IP68



Chassis socket acc. to IEC 61076-2-106, IP68, with threaded joint, for printed circuit boards, for front mounting

03 0306

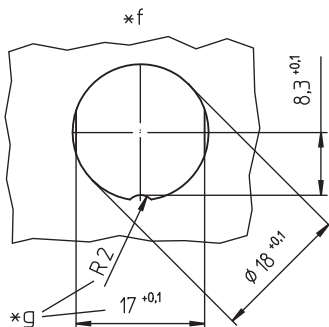
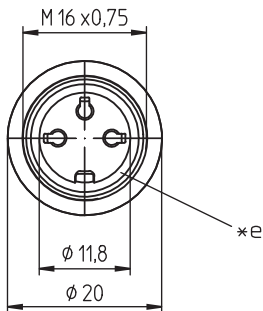
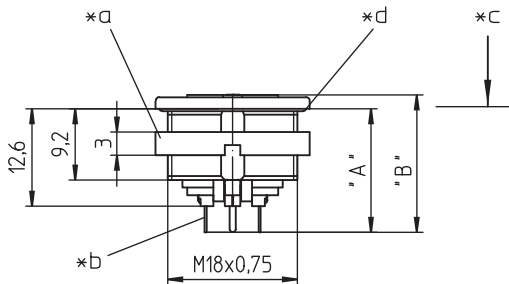
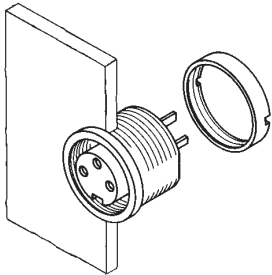

### Environmental conditions

Temperature range -40 °C/+85 °C

### Materials

Insulating body	PA GF, V-0 according to UL94
Contact bush	CuZn, silver-plated and flash gold-plated, tin-plated in solder area (3-8 poles) CuZn, pre-nickel and gold-plated, tin-plated in solder area (12-14 poles)
Housing	Zn diecast, pre-copper and nickel-plated
Ring screw	CuZn, nickel-plated
Seal	CR (flat), NBR (O-ring)

### Mechanical data

Insertion force/contact	$\leq 5.0 \text{ N}^1$
Withdrawal force/contact	$\geq 1.2 \text{ N}$ (3-8 poles) $\geq 0.9 \text{ N}$ (12-14 poles) <sup>1</sup>
Tightening torque connector	1-3 Nm
Tightening torque nut	1-3 Nm
Protection class	IP68 <sup>2</sup>

<sup>1</sup> measured with a polished steel pin, nominal thickness 1.5 mm (1.0 mm with 12-14 poles)

<sup>2</sup> according to IEC DIN EN 60529, only in locked condition with an appropriate counterpart; IPX8 requirements under agreement between manufacturer and user

### Electrical data (at $T_{\text{amb}} 20 \text{ °C}$ )

Contact resistance	$\leq 5 \text{ m}\Omega$
Rated current	5 A ( $T_{\text{amb}} 40 \text{ °C}$ , 3-8 poles) 3 A ( $T_{\text{amb}} 40 \text{ °C}$ , 12-14 poles)
Rated voltage	with pollution degree 1: 300 V (versions 03, 04, 05-1, 06, 07) 100 V (versions 05, 07-1, 08, 08-1) 160 V (versions 12, 14) with pollution degree 2: 250 V (versions 03, 04) 32 V (versions 05, 07-1, 08, 08-1) 160 V (versions 05-1, 06, 07, 12, 14)
Rated impulse voltage	1500 V (versions 03, 04, 05-1, 06, 07, 12, 14) 500 V (versions 05, 07-1, 08, 08-1)
Material group	II (IEC)/I (UL) (400 $\leq$ CTI < 600)
Overvoltage category	I
Insulation resistance	> 100 M $\Omega$

**03 0306**

**Pin configurations, solder side view**

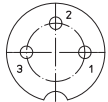

**03-a**  
**0306 03**

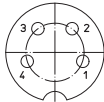

**04-a**  
**0306 04**

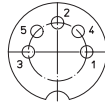

**05-b**  
**0306 05**

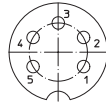

**05-a**  
**0306 05-1**

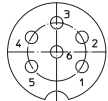

**06-a**  
**0306 06**

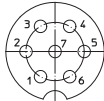

**07-a**  
**0306 07**

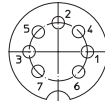

**07-b**  
**0306 07-1**

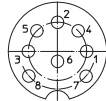

**0306 08**



**08-a**  
**0306 08-1**





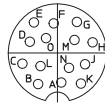



**12-a**  
**0306 12**









**14-a**  
**0306 14**

**Associated products**

Counterparts

- |  |  |  |
|--|--|--|
|  0331   |  0332 |  0332-1 |
|  033200 |  0365 |  036500 |

Accessories

- |   |  |  |
|---|--|--|
|  0322 C 16 |  0381 |  038199 |
|  0382      |  0384 |  0385   |
|  038799    |  |  |

Harnessing equipment

-  ZMS 20

03 0306

Printed circuit board layout, solder side view

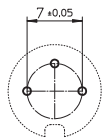

03-a  
0306 03

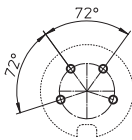

04-a  
0306 04

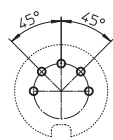

05-b  
0306 05

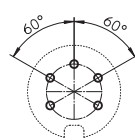

05-a  
0306 05-1

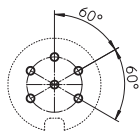

06-a  
0306 06

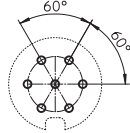

07-a  
0306 07

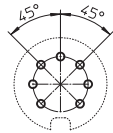

07-b  
0306 07-1

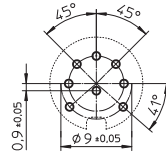

0306 08

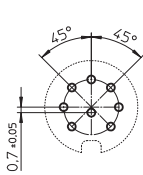

08-a  
0306 08-1

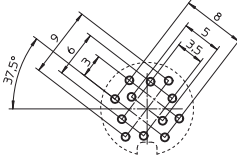

12-a  
0306 12

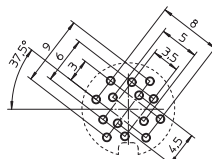

14-a  
0306 14

- \*a nut enclosed separately
- \*b for bore hole of PCB  
Ø 1,0 mm (0306 03-0306 08-1)  
Ø 0,7 mm (0306 12-0306 14)
- \*c mounting direction
- \*d O-ring gasket
- \*e flat gasket
- \*f port in mounting plate
- \*g anti-rotation, alternative execution

03 0306

Designation	Pole Number	PU (Pieces)	MDQ (Pieces)	Dimensions	
				A (mm)	B (mm)
0306 03	3	50	100	16.0	17.8
0306 04	4	50	100	16.0	17.8
0306 05	5	50	100	16.0	17.8
0306 05-1	5	50	100	16.0	17.8
0306 06	6	50	100	16.0	17.8
0306 07	7	50	100	16.0	17.8
0306 07-1	7	50	100	16.0	17.8
0306 08	8	50	100	16.0	17.8
0306 08-1	8	50	100	16.0	17.8
0306 12	12	50	100	15.6	17.1
0306 14	14	50	100	15.6	17.1

**Packaging:**  
in a cardboard box