

03 0308-1

Circular connectors with threaded joint M16 acc. to IEC 61076-2-106, IP40/IP68



Flange chassis socket acc. to IEC 61076-2-106 and AISG specification, IP68, with threaded joint and solder terminals, for front mounting

03 0308-1

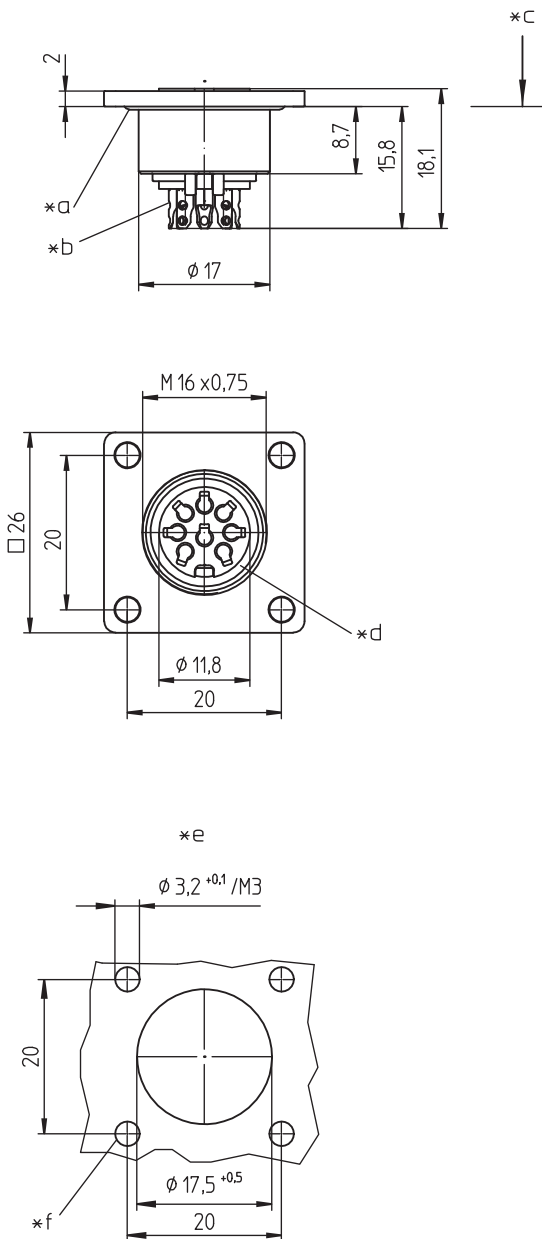

Environmental conditions

Temperature range -40 °C/+85 °C

Materials

Insulating body	PA GF, V-0 according to UL94
Contact bush	CuZn, silver-plated and flash gold-plated
Housing	Zn diecast, pre-copper and nickel-plated
Seal	CR (flat), EPDM (O-ring)

Mechanical data

Insertion force/contact	≤ 5.0 N ¹
Withdrawal force/contact	≥ 1.2 N ¹
Tightening torque connector	1-3 Nm
Tightening torque nut	1-3 Nm
Protection class	IP68 ²

¹ measured with a polished steel pin, nominal thickness 1.5 mm

² according to IEC DIN EN 60529, only in locked condition with an appropriate counterpart; IPX8 requirements under agreement between manufacturer and user

Connectable conductors for solder area







Section ≥ 0.75 mm² (AWG 20)



Electrical data (at T_{amb} 20 °C)

Contact resistance	≤ 5 mΩ
Rated current	5 A (T _{amb} 40 °C)
Rated voltage	100 V (with pollution degree 1) 32 V (with pollution degree 2)
Rated impulse voltage	500 V
Material group	II (IEC)/I (UL) (400 ≤ CTI < 600)
Overvoltage category	I
Insulation resistance	> 100 MΩ



Associated products

Counterparts

 0331	 0332	 0332-1
 033200	 0365	 036500

 Weitere Produkte auf Anfrage	 Weitere Produkte auf Anfrage
--	--

Accessories

 0308 C 02	 0322 C 16	 0381
---	---	--

03 **0308-1**

Pin configurations, solder side view

 038199

 038799

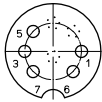

***g**
 0308-1 05-3

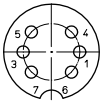

-

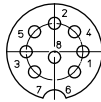

08-a
 0308-1 08-1

- *a O-ring gasket
- *b cup-shaped solder terminal
- *c mounting direction
- *d flat gasket
- *e port in mounting plate
- *f provide for suitable sealing of screws
- *g pin configuration according to AISG C485

03

0308-1

Designation	Pole Number	PU (Pieces)	MDQ (Pieces)
0308-1 05-3	5	50	100
0308-1 08-1	8	50	100

Packaging:

in a cardboard box