

15

1503 22

Jack connectors

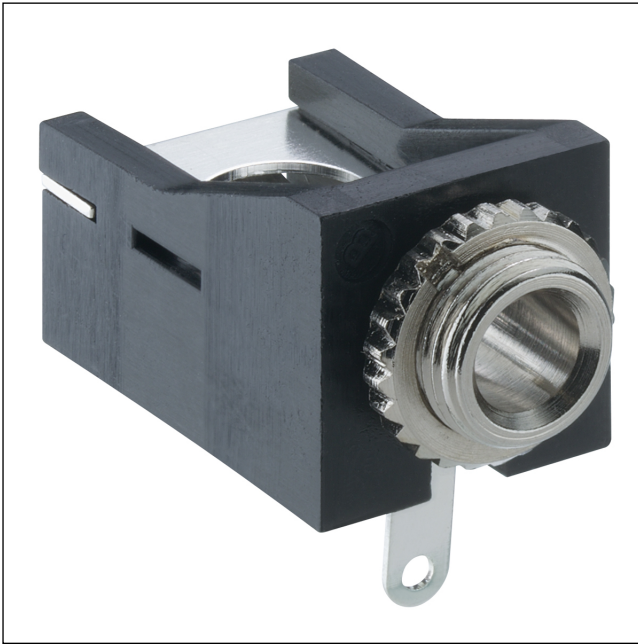

Jack chassis socket acc. to JIS C 6560 JC35J2B, 3.5 mm, 2 poles/mono, angular version, with break contact and solder eyes, for printed circuit boards, for back side mounting

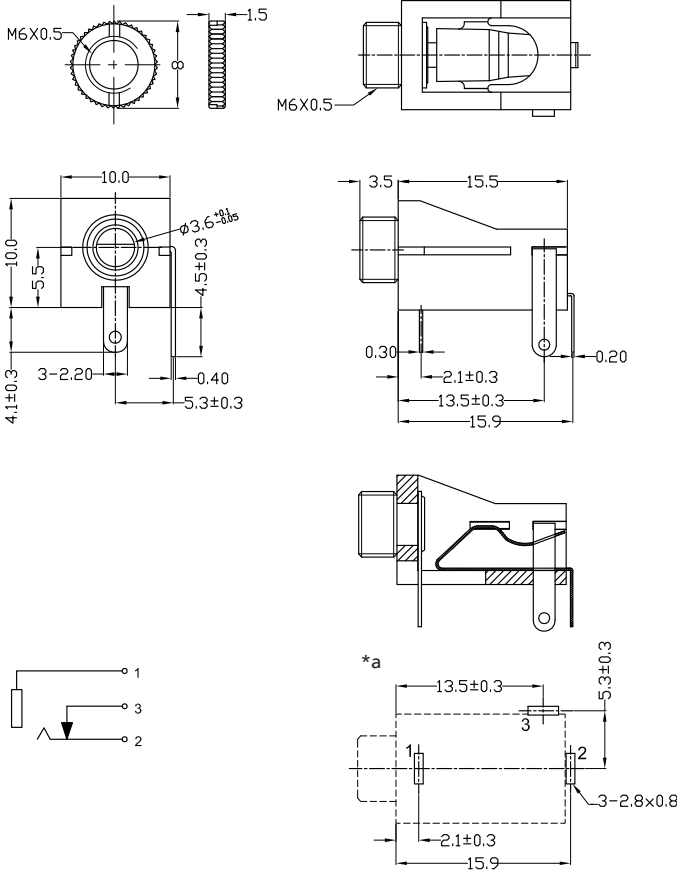

*a printed circuit board layout, solder side view

Environmental conditions

Temperature range -16 °C/+65 °C

Materials

Insulating body	PBT, V-0 according to UL94
Contact bush	CuZn, nickel-plated
Lötkontakt	CuZn/St, tin-plated
Knurled nut	CuZn, nickel-plated





Mechanical data

Mating cycles	≥ 5000
Insertion force	2,9–29,4 N
Withdrawal force	2,9–29,4 N

Electrical data (at T_{amb} 20 °C)

Contact resistance	≤ 50 mΩ
Rated current	1 A
Rated voltage	12 V
Insulation resistance	≥ 100 MΩ

Associated products

Counterparts			
 1532 04	 1532 06	 KLS 2	
 KLS 22	 WKLS 2		

Accessories	
 1597 02	 1597 04

15

1503 22

Designation	Pole Number	PU (Pieces)	MDQ (Pieces)
1503 22	2	500	500

Packaging:

in bulk, in a cardboard box or a plastic bag