

16

1633 02

Power supply connectors



Power supply plug, straight version, with solder eyes and bend protection

16

1633 02

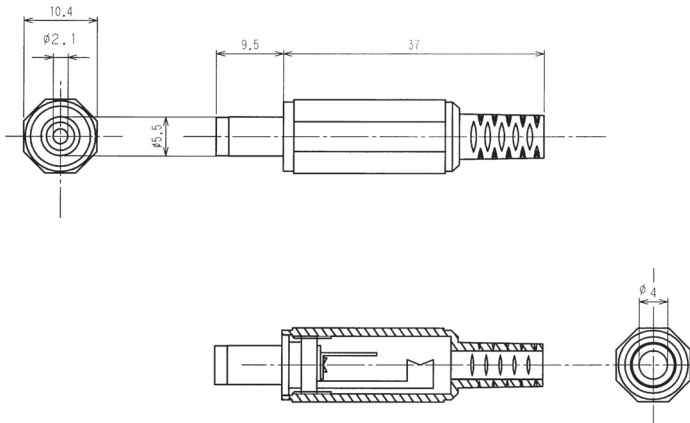

Environmental conditions

Temperature range -20 °C/+70 °C

Materials

Insulating body	PF
Contact	Cu alloy, nickel-plated
Insulation	POM
Housing	PE

Mechanical data

Outer diameter	5.5 mm
Inner diameter	2.1 mm

Connectable conductors for solder area















Cable diameter 4 mm

Electrical data (at T_{amb} 20 °C)

Rated current	3 A
Rated voltage	24 V DC
Rated impulse voltage	500 V/60 s
Insulation resistance	$\geq 100 \text{ M}\Omega$

Associated products

Counterparts

 1610 06	 1613 14	 1613 18
 1613 28	 1613 30	 1613 32
 1614 09	 1614 14	 1614 19
 1614 23	 NEB 21 R-C	 NEB/J 21
 NEB/J 21 C	 NEB/J 21 R	 NEK/J 210

16

1633 02

Designation	Pole Number	PU (Pieces)	MDQ (Pieces)
1633 02	2	100	500

Packaging:

in bulk, in a cardboard box or a plastic bag