

35

3542

RAST 2.5 connectors, pitch 2.5/5.0 mm

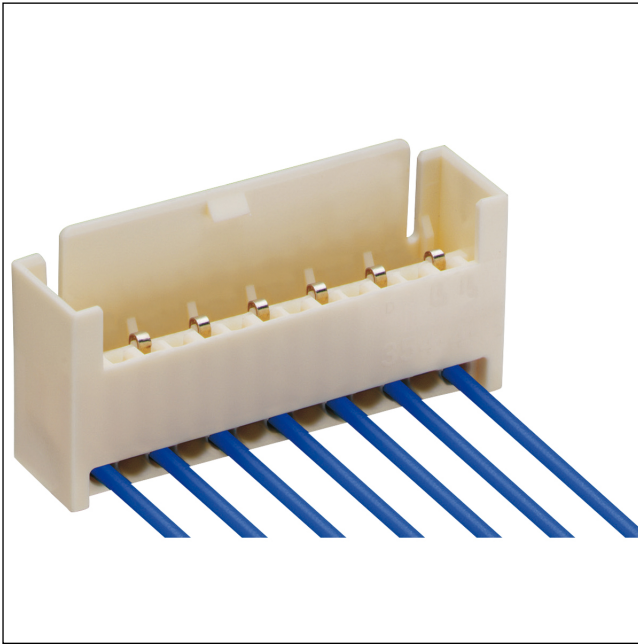

RAST 2.5 pin header, insulation displacement technology (IDT), with locking latch
contact pitch 5.0 mm

Approvals:



35 3542

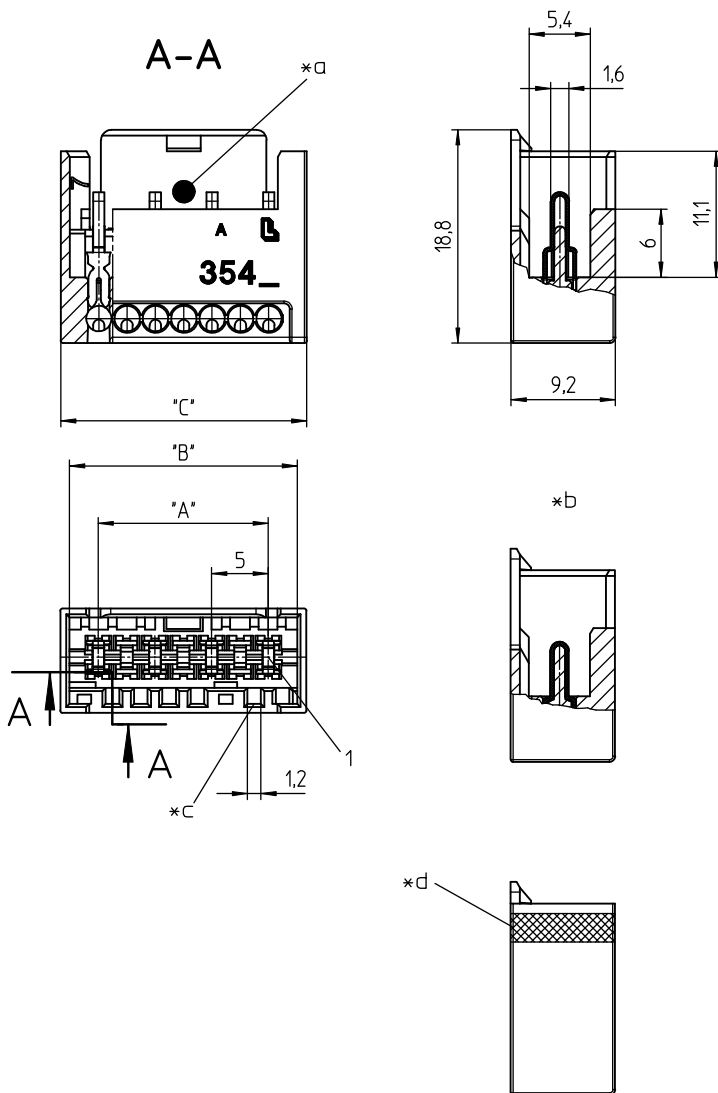

- *a blue color marking on 3542 (M...)S01
- *b terminated connector
- *c keying
- *d space for customer-specific color marking (FB)

Environmental conditions

Temperature range -40 °C/+120 °C¹

¹ upper limit temperature (insulating body) RTI (electrical) of the UL Yellow Card

Materials

Insulating body PA GF, V-0 according to UL94 – 3542 M13(S...)¹

Contact pin CuSn, tin-plated

¹ component glow wire resistant (GWT 750 °C), testing acc. to IEC 60695-2-11, assessment acc. to IEC 60335-1 (flame < 2 s)

Mechanical data

Keying proposals at www.lumberg.com 

Connectable conductors for IDT area

Construction discrete conductor, notched flat cable 2.5 mm

Section min. 0,22 mm²

Section max. 0,50 mm²

Insulation diameter ≤ 1,65 mm

Approved cables at www.lumberg.com 

Electrical data (at T_{amb} 20 °C)

Rated current 4 A (T_{amb} 60 °C)
2 A (T_{amb} 110 °C)
6 A (T_{amb} 85 °C, only with 3570)
4 A (T_{amb} 105 °C, only with 3570)

Rated voltage 250 V AC¹

Material group IIIa (IEC)/2 (UL) (CTI ≥ 250)¹

Creepage distance 3,8 mm



Clearance 4,0 mm

Insulation resistance > 1 GΩ

¹ according to IEC 60664/DIN EN 60664, CTI UL classification according to ANSI/UL 746A

Associated products

Counterparts

 3523  3523-2  352300

 3570  357000

Harnessing equipment

 HA3...e  HA354e-ST  HZ354

 KHP3541/42-SW  VARICON 7000-Eco  VARICON 7000-Eco-CR

 VARICON 7000-RD

35

3542

35

3542

Designation	Pole Number	PU (Pieces)	MDQ (Pieces)	Dimensions		
				A (mm)	B (mm)	C (mm)
3542 02	2	500	1000	5	10.1	11.7
3542 03	3	500	1000	10	15.1	16.7
3542 04	4	500	1000	15	20.1	21.7
3542 05	5	500	1000	20	25.1	26.7
3542 06	6	500	1000	25	30.1	31.7
3542 07	7	500	1000	30	35.1	36.7
3542 08	8	500	1000	35	40.1	41.7
3542 09	9	500	1000	40	45.1	46.7
3542 10	10	500	1000	45	50.1	51.7

Designation to be completed by further details (e.g. for keying, color or material options).

Packaging:

in bulk, in a cardboard box – in bar stock carriers upon request