

36

3615-2

RAST 5 connectors, pitch 5.0 mm

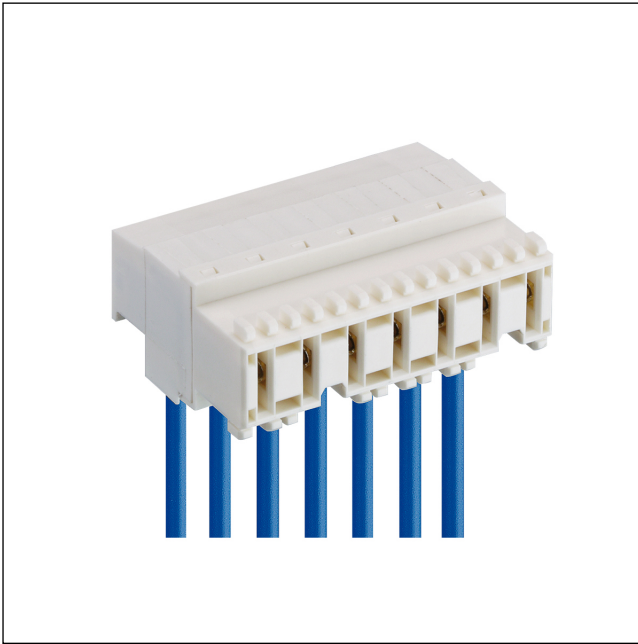

RAST 5 connector for indirect mating, with screw terminal, with lift clamp with protection against misplacing, with test holes and interior locking, consecutive placement without loss of pitch, cable departure on side of lock

Approvals:



36

3615-2

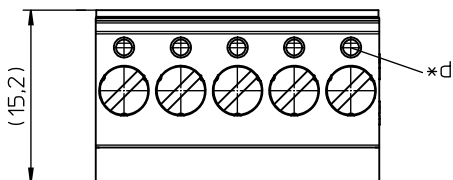
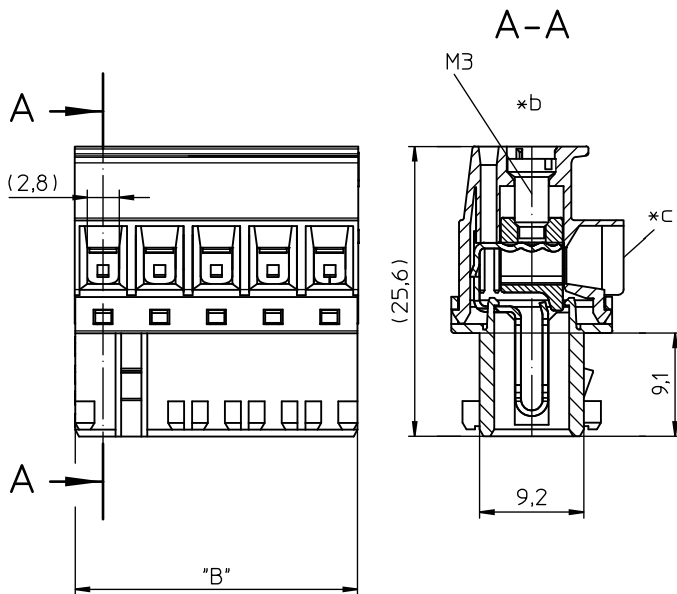
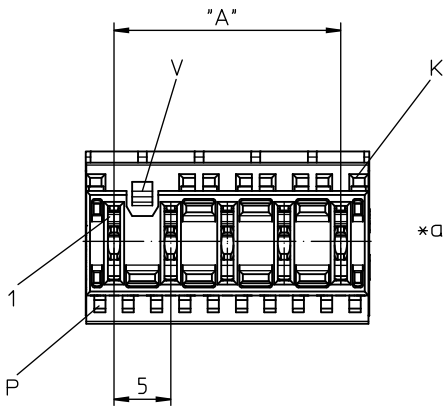

*a K = keying
P = positioning
V = lock

*b all screw clamps of the connector to be tightened with the indicated torque

*c cable departure 90°

*d hole for test spike \varnothing 1.3 mm

Environmental conditions

Temperature range -40 °C/+130 °C¹

¹ upper limit temperature (insulating body) RTI (electrical) of the UL Yellow Card

Materials

Insulating body	PA GF, V-2 according to UL94 ¹
Contact spring	CuSn, tin-plated
Clamp	CuZn, nickel-plated
Screw	steel, zinc-plated and chromatiert

¹ component glow wire resistant (GWT 750 °C), testing acc. to IEC 60695-2-11, assessment acc. to IEC 60335-1 (flame < 2 s)

Mechanical data

Mating with	tab contact 6.3 mm x 0.8 mm according to DIN 46244
Insertion force/contact	≤ 4,0 N
Withdrawal force/contact	≥ 1,0 N
Tightening torque screw	0,5 Nm
Keying proposals	at www.lumberg.com 













Connectable conductors for screw clamp

Section stranded wire	0,14–2,5 mm ² (AWG 26–14)
Section stranded wire with ferrule	0,25–2,5 mm ² (AWG 24–14)
Section solid wire	0,14–4,0 mm ² (AWG 26–12)
Stripping length	8 ± 1 mm

Electrical data (at T_{amb} 20 °C)

Contact resistance	≤ 5 mΩ
Rated current	10 A (T _{amb} 70 °C)
Rated voltage	250 V AC
Material group	IIIa (IEC)/2 (UL) (CTI ≥ 250)
Creepage distance	3,5 mm
Clearance	3,5 mm
Insulation resistance	> 10 GΩ

Associated products

Counterparts			
 3618	 3618-1	 3618-2	
 3618-3	 361899	 361899-1	
 361899-2	 361899-3	 3641	
 364199	 3642	 364299	

3643	364399	3644
364499	3645	364599
3647	3648	3649
3671	367199	3672
367299	3673	367399
3674	367499	3676
3677	3678	3679
3680	3683	

Designation	Pole Number	PU (Pieces)	MDQ (Pieces)	Dimensions	
				A (mm)	C (mm)
3615-2 02	2	200	1000	5	9.9
3615-2 03	3	200	1000	10	14.9
3615-2 04	4	200	1000	15	19.9
3615-2 05	5	200	1000	20	24.9
3615-2 06	6	200	1000	25	29.9
3615-2 07	7	200	1000	30	34.9

Designation to be completed by further details (e.g. for keying, color or material options).

Packaging:

in bulk, in a cardboard box