

36

3618-3

RAST 5 connectors, pitch 5.0 mm



RAST 5 tab header, with screw terminal, with lift clamp  
with protection against misplacing, with test holes, cable  
departure on side of lock, with handle latch

---

Approvals:



36 3618-3

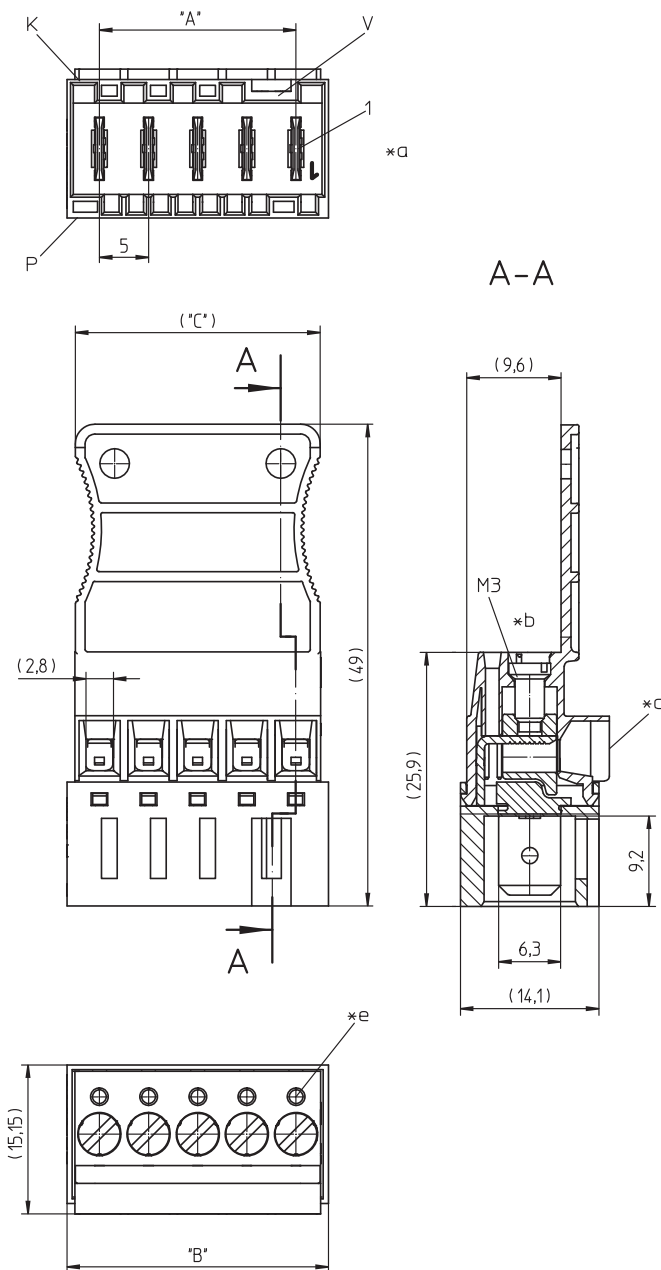

- \*a K = keying  
P = positioning  
V = space for lock
- \*b all screw clamps of the connector to be tightened with the indicated torque
- \*c cable departure 90°
- \*e hole for test spike  $\varnothing$  1.3 mm

### Environmental conditions

Temperature range -40 °C/+130 °C<sup>1</sup>

<sup>1</sup> upper limit temperature (insulating body) RTI (electrical) of the UL Yellow Card

### Materials

Insulating body PA GF, V-2 according to UL94<sup>1</sup>  
 Contact tab CuZn, tin-plated  
 Clamp CuZn, nickel-plated  
 Screw steel, zinc-plated and chromatiert

<sup>1</sup> component glow wire resistant (GWT 750 °C), testing acc. to IEC 60695-2-11, assessment acc. to IEC 60335-1 (flame < 2 s)

### Mechanical data

Contact tab 6.3 x 0.8 mm according to DIN 46244  
 Tightening torque screw 0,5 Nm  
 Keying proposals at [www.lumberg.com](http://www.lumberg.com) 













### Connectable conductors for screw clamp

Section stranded wire 0,14–2,5 mm<sup>2</sup> (AWG 26–14)  
 Section stranded wire with ferrule 0,25–2,5 mm<sup>2</sup> (AWG 24–14)  
 Section solid wire 0,14–4,0 mm<sup>2</sup> (AWG 26–12)  
 Stripping length 8 ± 1 mm

### Electrical data (at T<sub>amb</sub> 20 °C)

Contact resistance ≤ 5 mΩ  
 Rated current 10 A (T<sub>amb</sub> 70 °C)  
 Rated voltage 250 V AC  
 Material group IIIa (IEC)/2 (UL) (CTI ≥ 250)  
 Creepage distance 3,5 mm  
 Clearance 3,5 mm  
 Insulation resistance > 10 GΩ

### Associated products

Counterparts  
 3611  3615  3615-1  
 3615-2  3615-3  3623  
 3623 01 V01  3626  3680  
 3683  3686  3687

36

3618-3

Designation	Pole Number	PU (Pieces)	MDQ (Pieces)	Dimensions		
				A (mm)	B (mm)	C (mm)
3618-3 02	2	200	1000	5	11.6	9.3
3618-3 03	3	200	1000	10	16.6	14.3
3618-3 04	4	200	1000	15	21.6	19.3
3618-3 05	5	200	1000	20	26.6	24.3
3618-3 06	6	200	1000	25	31.6	29.3
3618-3 07	7	200	1000	30	36.6	34.3

Designation to be completed by further details (e.g. for keying, color or material options).

**Packaging:**

in bulk, in a cardboard box